

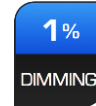

M109 D LINEAR LED LIGHT

V.2.7.2
11/13/19

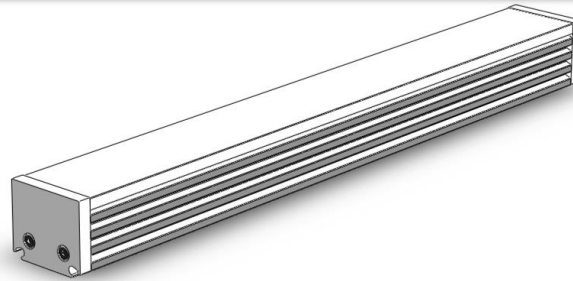

Benefits

- **Plug & Play Installation**
- Cable length from PS up to 100 feet.
- **No variance in color temperature or light output.**
- **California Title 24 listed, JA8 2016**
- No UV radiation
- Made to exact & continuous length.
- High efficiency
- Usable for both mood and task lighting.
- No assembly required
- Small Foot-print
- **1% Flicker Free Dimming**

Features

- Seamless and fully dimmable.
- Color temperature changing feature when dimming.
- Continuous fixture length up to 12 feet.
- Programmable color temperature (CCT) pre and post installation to match decor.



SPECIFICATIONS	M109 D
Housing	Clear Anodized Aluminum
Style	Straight or Low Profile
Dimensions	0.87" x 1.0" x length or 0.675" x 1" x length
Length	Up to 120" (continuous)
Weight	7.5 oz/ft
Environment	Indoor, Damp
Mounting	Spring Clip Tape for Low-Profile available
Light cover	Frosted PMMA Diffuser
Input voltage	Low Voltage, 24 VDC
Power Supply	EST PCU-4 M109 100W Class 2
Cable on Light	CMR Rated, 20/4 gauge, EST Male Connector
Cable from PCU to Light	CMR Rated, 20/4 gauge, EST Female Connector
Wattage	8.5 W/ft 6 W/ft for Low-Profile Version
System Efficacy	63 Lm/W
LED	EST light engine
Color temperature (CCT)	1800 to 3100 K [Pre/Post Adjustable]
Color Rendering Index (CRI)	92 typical
R9	56 typical
Lumen output	600 Lm/ft 420 Lm/ft for Low-Profile
Beam angle	Wide / [Inquire for custom options]
Light beam	Soft Edged
Dimming	Seamless & Fully dimmable
Life Time	50,000 Hrs
Warranty	3 Years
Certifications	UL Listed (E464414) JA8-2016 Listed (CA Title-24)

DIMENSIONS

M109 D - S (Straight Profile)		M109 D - L (Low Profile)	
No mounting Clip	Incl. Mounting Clip	No Mounting Clip	Incl. Mounting Clip

MOUNTING

Spring Clip mounted for easy installation.

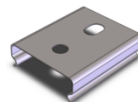
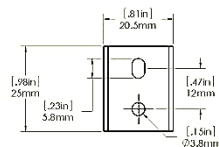

DIMMER COMPATIBILITY

Dimmer Type	Dimming level
Lutron Wall Dimmer DVELV	2-100%
Lutron Graphic Eye PHPM-PA	2-100%
Lutron Home Works HW-RPM-4A	2-100%

* Do NOT use Lutron CFL/LED dimmer

CONNECTOR

	On M109 (Female)	PCU to Light (Male)	Connected
Length	1.4"	1.5"	2.6" [66mm]
Diameter Ø	0.41"	0.42"	0.42" [11mm]

EST Energy Savings Technology, LLC

47889 Fremont Boulevard + 408 586 8696
Fremont, CA 94538 www.est-es2.com
USA info@est-es2.com

Spec sheets are subject to change without notice.
© 2014 Energy Savings Technology



M109 D LINEAR LED LIGHT

M109 LENGTH INFO

The length can be custom specified up to a continuous 120 inches. For longer lengths please contact us.

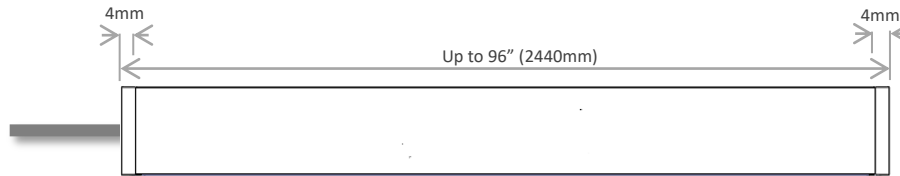

CABLE CONFIGURATION / LENGH INFO

The M109 lamp comes standard with a connector length of 12 inches (1 foot) including a female connector for trouble-free linking between power source and lamp (Indicated by X in the figure below.). The lamp can be custom ordered with a connection length up to 100 feet including the connector. The CCF-109 cable comes standard as 120 inches (10-foot) but can be custom ordered to a length up to 100 feet. The CCF-109 comes with a male linkage to connect to the M109 lamp female connector and can be field cut to the required length. The total length of the cable between power supply and the lamp is advised to be under 100 feet. All cables are CMR rated.

	Standard	Custom
X (attached cable length)	1'	Up to 100'
CCF M109	10'	Up to 100'
Total length (X+CCF)		Max 100'

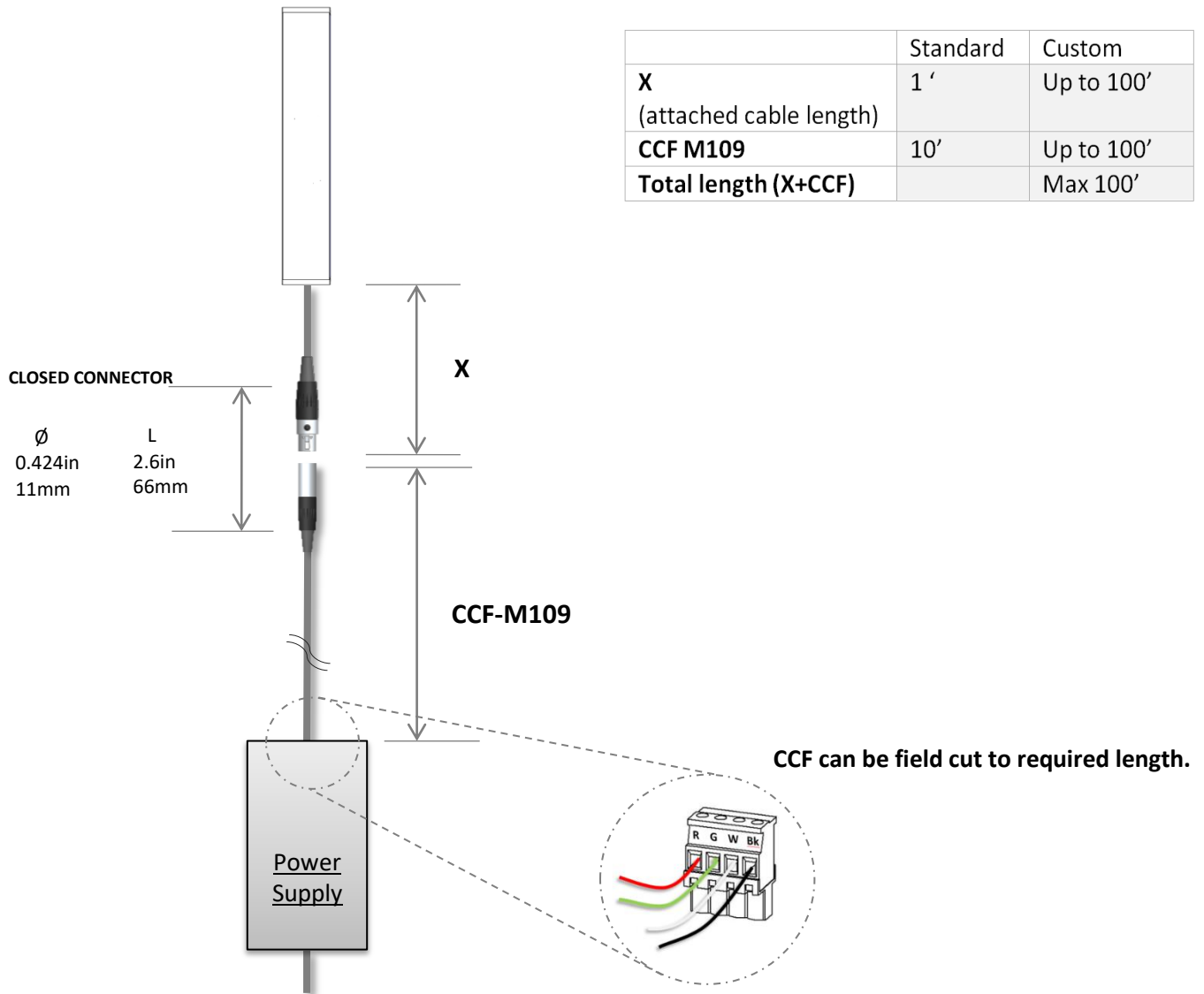



M109 D LINEAR LED LIGHT

Order Information

To order, select the desired option from each category and place in the corresponding box. Available options are shown and described on the previous pages or in the part numbers catalog. For additional options not shown in the catalog, please contact us.

* Information displayed in gray is standard configuration.

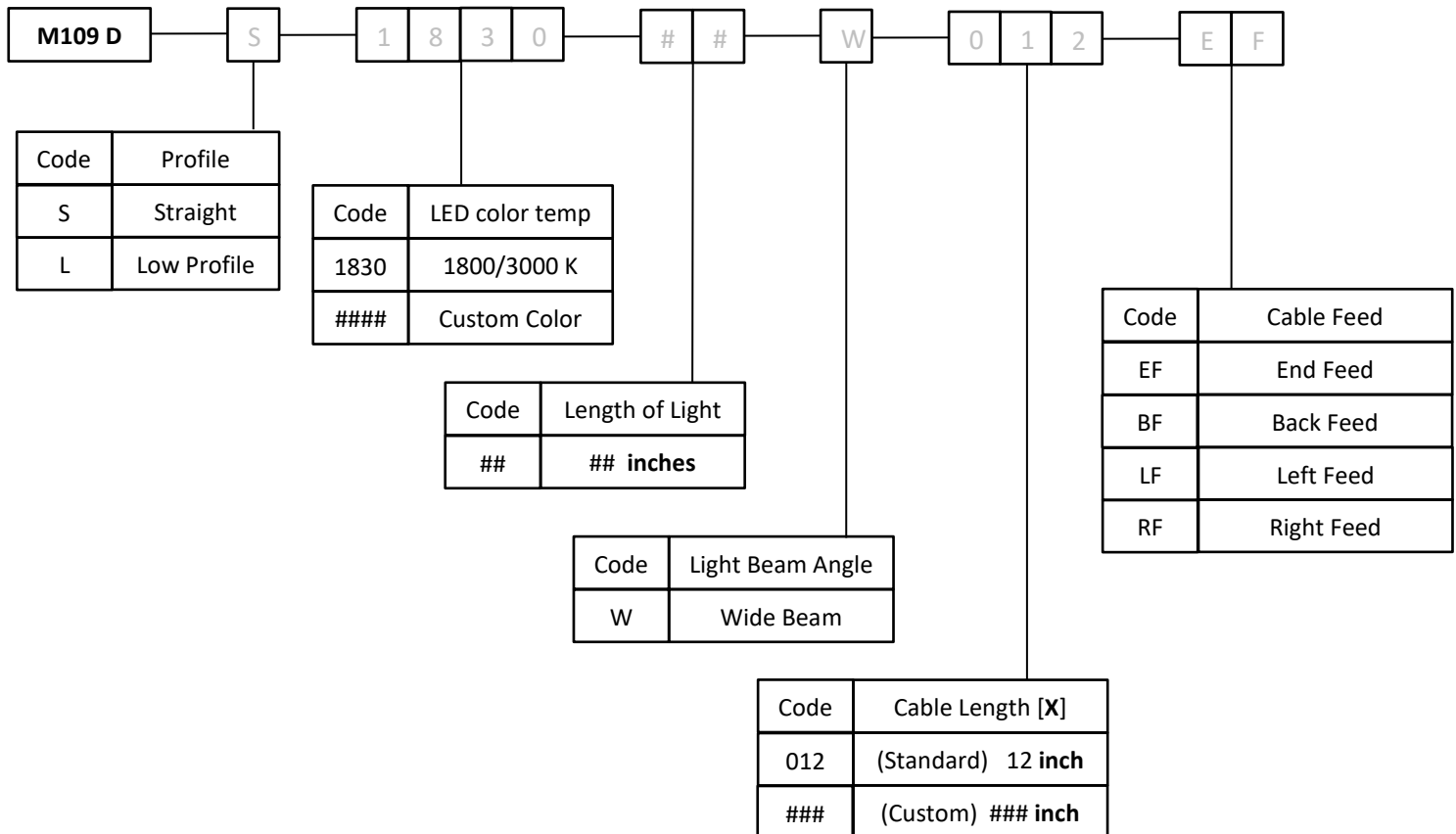

Example: **M109D-S-1827-44-W-012-BF**

Product	M109
Style	Straight
LED Color	1827 K
Length	44 inches
Light Beam	Wide
Cable length on Light (X)	12 inches (1 foot) (On M109)
Cable Feed Direction	Back Feed

⚠ Order M109 CCF cable!

Cable from power supply to M109 linear LED light connector up to 100 feet: **CCF-M109-15**

*Please specify length in feet.

Product	CCF M109 cable with connector
Cable Length (CCF)	15 feet

