

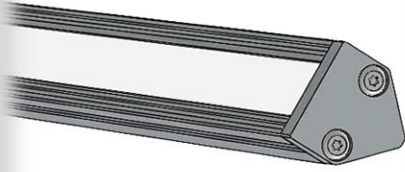

# M116-45 LINEAR LED LIGHT

V.2.6.2  
06/10/17



## Benefits

- Plug & Play Installation
- UL Listed
- Under/In cabinet & In closet use
- Cable length from PS up to 100 feet.
- No variance in light output or color temperature.
- No UV radiation
- Full customization
- High efficiency
- Small Foot-print

## Features

- Seamless and fully dimmable.
- Continuous lamp length up to 10 feet.
- 45° light output

## SPECIFICATIONS

SPECIFICATIONS	M116-45
Housing	Clear Anodized Aluminum
Style	45° Mount
Dimensions	0.65" x 0.65" x [Custom]" [H x W x L]
Length	Up to 120" in 2" increments (continuous)
Weight	3 oz/ft
Environment	Indoor
Mounting	3M Double Sided Tape
Light cover	Frosted Polycarbonate Diffuser
Input voltage	Low Voltage, 24 VDC
Power Supply	EST PCU-2-M116 100W Class 2 ELV Power supply
Wattage	4.5 W/ft
Efficacy	60 Lm/W
Cable on Light	CRM rated; 20/2 gauge with EST male connector <i>OR</i> No male connector for field connection
Cable from PCU to Light	CRM rated; 18/2 gauge with EST female connector up to 100 feet.
LED	EST light engine
Color temperature (CCT)	2700 / 3000 / 3500
Color Rendering Index (CRI)	> 90
Lumen output	250 Lm/ft
Beam angle	Wide, 120°
Light beam	Soft Edged
Dimming	Seamless & Fully dimmable
Life Time	60,000 Hrs
Warranty	3 Years
Certifications	UL Listed, Under/In cabinet & In closet use

## DIMENSIONS

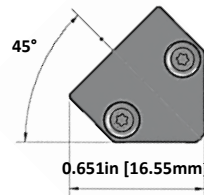

## MOUNTING

3M double sided tape (Standard)

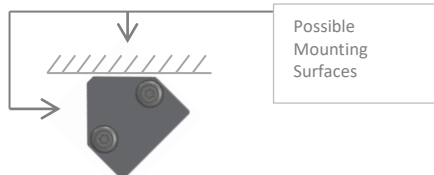

Actual Size

## DIMMER COMPATIBILITY

Dimmer Type*	Dimming level
<b>With EST PSU option</b>	
Lutron Wall Dimmer DVELV 300/303 PH	2-100%
Lutron Graphic Eye PHPM-PA	2-100%
Lutron Home Works HW-RPM-4A	2-100%

\* Do NOT use Lutron CFL/LED dimmer

## CONNECTOR

	On M116-45 (Male)		PCU to Light (Female)		Connected	
Length	1.1"		1.5"		2.2"	
Diameter Ø	0.3"		0.4"		0.4"	

**EST** Energy Savings Technology, LLC

47889 Fremont Boulevard + 408 586 8696  
Fremont, CA 94538 www.est-es2.com  
USA info@est-es2.com

Spec sheets are subject to change without notice.  
© 2014 Energy Savings Technology

### RECESS

The M116-45 can be recessed by 7/32" to protrude only 7/16<sup>th</sup> inches.

1. To recess route a channel at: **0.22" H x 0.70" W**
  - a. Routing at a width of 11/16<sup>th</sup> (0.687") is possible but must be exact.
  - b. Actual light fixture width is 0.651".
  - c. Maximum depth is 0.22"; this is to ensure there are no hotspots.
2. Rout slot with an **additional 1 inch in length** to accommodate wiring.
3. Before installing ensure that routed channel is completely clean.

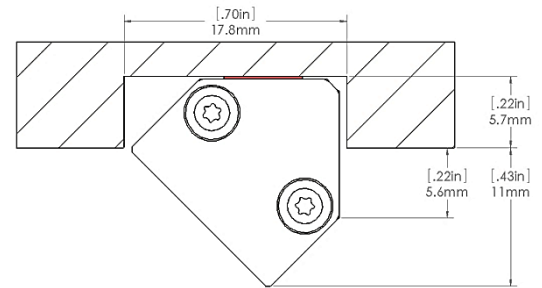

### M116 FIXTURE LENGTH

The length of the M116-45 can be custom specified up to a continuous 120" in length. For longer lengths please contact us.

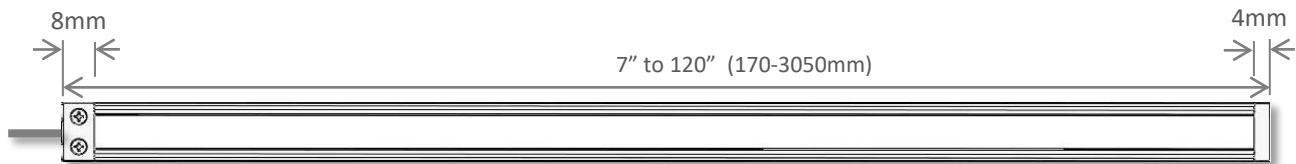

## CABLE CONFIGURATION / LENGTH INFO

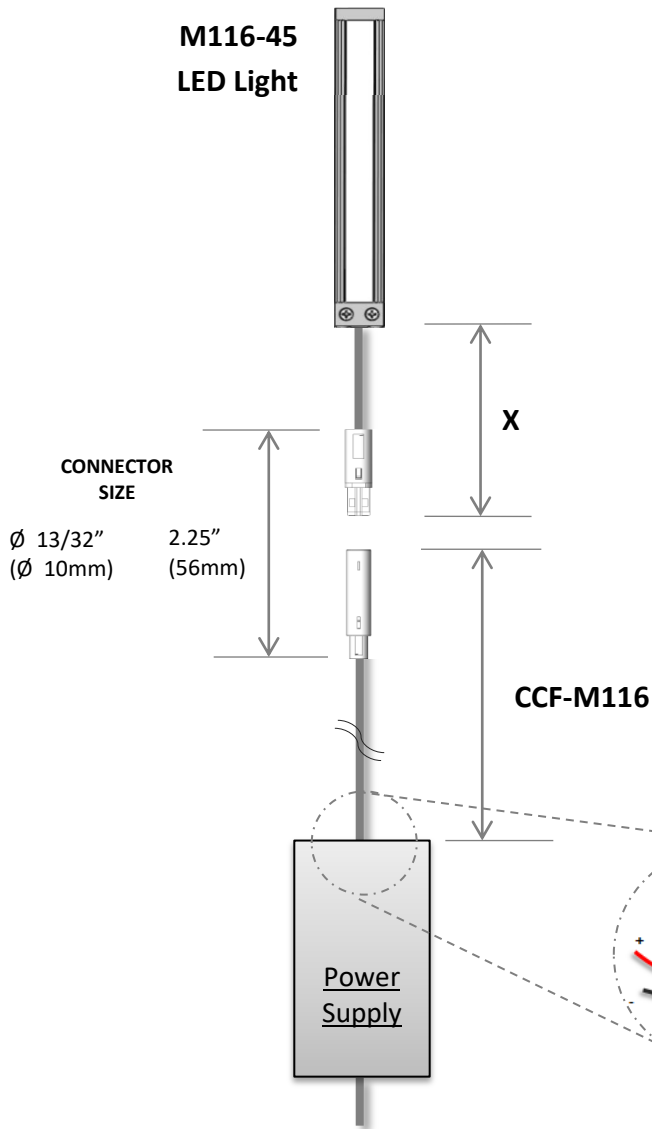

The M116 LED light comes standard with a pigtail cable of 1 foot including a male connector for ease of connecting the power source and lamp (Indicated by X in the figure). The length of the pigtail on the M116-45 light can be custom ordered to up to 100 feet.

The CCF-116 cable comes standard as 10-foot but can be custom ordered to a length up to 100 feet. The CCF-116 comes with a female connector to connect to the M116-45 lamps male connector and can be field cut to the required length. The total length of the cable between the Power supply and the lamp is advised to be under 100 feet.

	Standard	Custom
<b>X</b> (attached cable length)	1'	Up to 100'
<b>CCF M116</b>	10'	Up to 100'
<b>Total length (X+CCF)</b>		Max 100'

**CCF can be field cut to required length and then connected to terminal plug.**

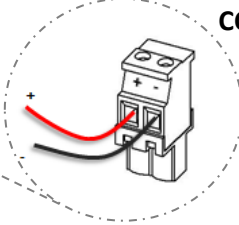

## OPTIONAL WIRING DIAGRAMS

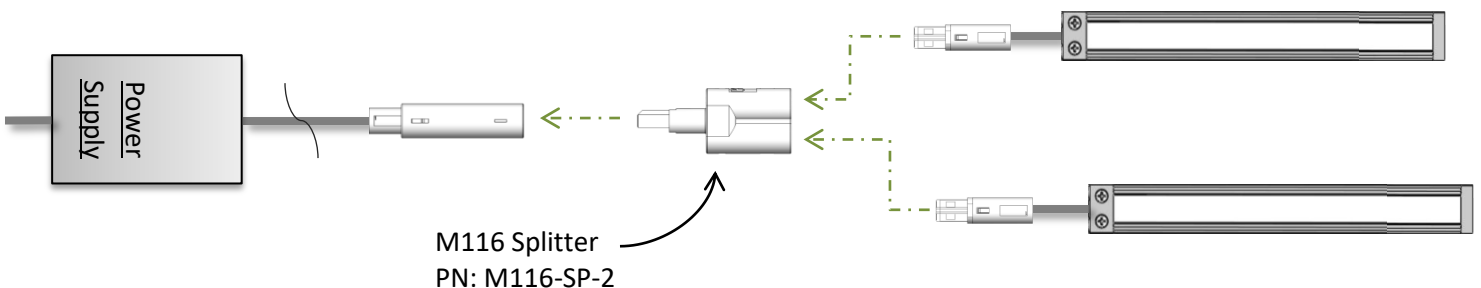

### Order Information

To order, select the desired option from each category and place in the corresponding box. Available options are shown and described on the previous pages or in the part numbers catalog. For additional options not listed in the catalog, please contact us.

\* Information displayed in gray is standard configuration.

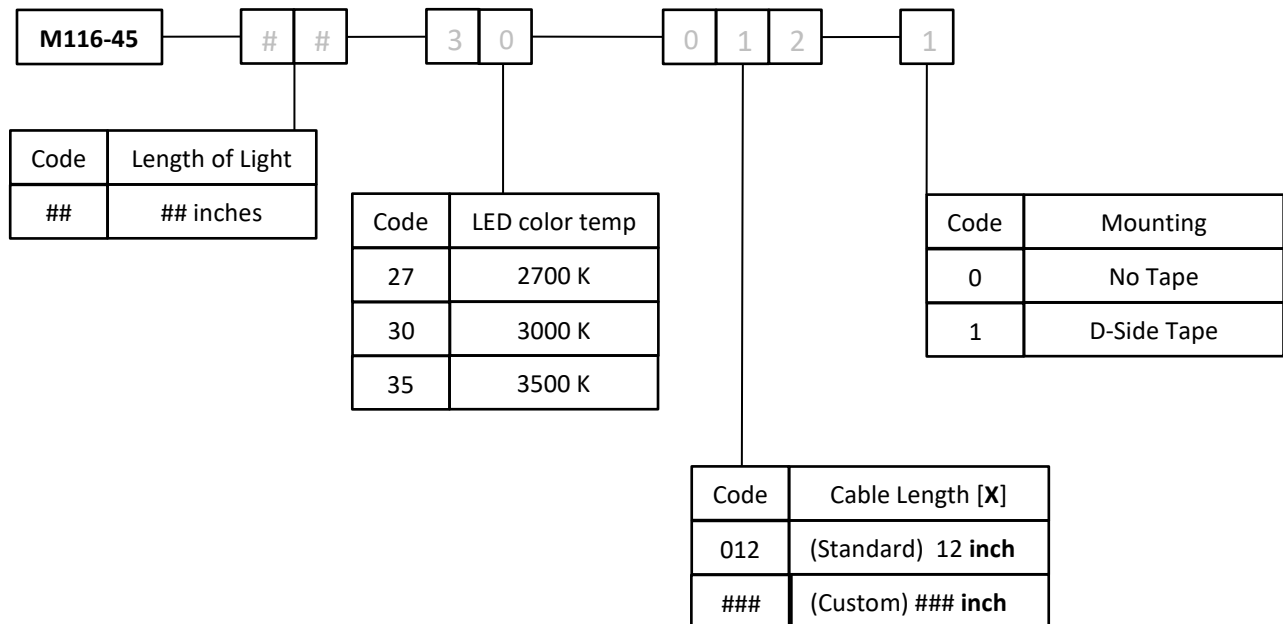

Order M116-45 Fixture Example: **M116-45-77-27-015-1**

Product	M116
Fixture Length	77 inches
LED color	2700 K
Cable length (X)	15 inches (On M116)
Mounting	Double side tape

**⚠ Order M116 CCF cable!**  
Cable from power supply to M116-45 lamp connector up to 100 feet: **CCF 116-10**

\*Indicate length in feet

Product	CCF 116 cable with connector
Cable Length (CCF)	10 feet